

CHRYSLER

300 / F

an exciting story for those who appreciate greatness in an automobile



THE
300/F

is the sixth of a celebrated breed...

a performance automobile of unique and varied talents. It is built by Chrysler in limited numbers.

Specially carved from a tradition that values engineering excellence; that considers an automobile a

total blend of many desirable factors. Like its famed predecessors, the 300-F is certain to earn

respectful attention wherever, whenever unusual automobiles are discussed, compared, analyzed.





Individual comfort served with tasteful dash. Separate bucket seats, finished in top-grain porous leather, offer supreme relaxation for driver and passengers. You sit proud and ready in the 300-F.

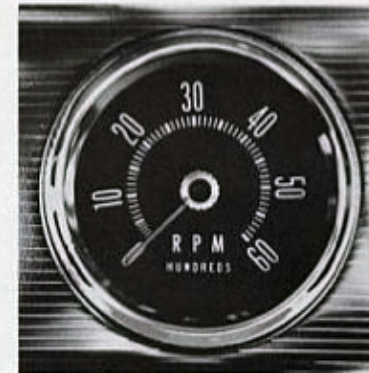

TACHOMETER. Records engine rpm's with un-wavering accuracy. An enthusiast's "must," it's located on central instrument console.

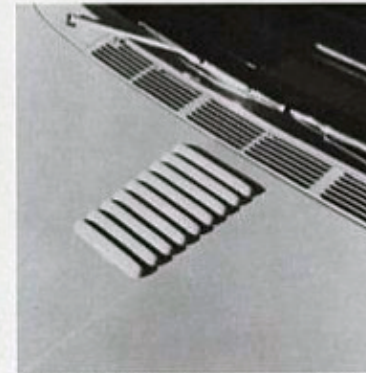

LOUVERS. Add a touch of sports-car spirit, provide a mark of special distinction for this very special made-for-moving automobile.

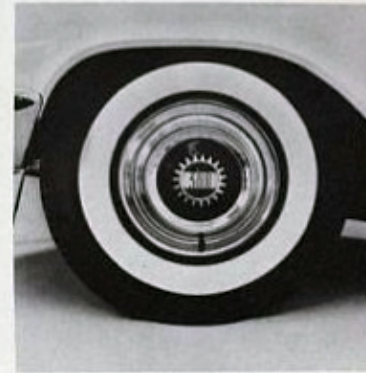

TIRES. Sports-racing type, equal to the 300-F's most rambunctious mood. You cover the miles in secure luxury.

BOLD CONFESSION. The look of the 300-F offers sure evidence that an exciting tradition continues in the automotive world. It is big beauty, tastefully restrained. Solid looks sweeping clean from sports-bred grille. Deep chrome, sparingly used. Particularly distinctive: flaring rear panels with embossed deck lid, hood louvers, specially designed wheel covers. This is smoldering style with a restless readiness for the road. After parking the 300-F, there is an irresistible urge to look back. Just to make sure it's still there.

INNER CIRCLE. The 300-F constantly surprises. Open the door: entry is graceful, unimpeded. Be seated: in individual bucket chairs designed for fullest support while you drive. Enter: stretch out, relax in leather-lined luxury. Room

unusual for a car of such fiery temperament.

Before your eyes, the most complete control center of any year. Gauges, big and readable. Bathed in soft, soothing Panelescent lighting while you drive at night. Pushbutton controls cluster within fingertip reach. And for the performance-minded, a wonderful plus: tachometer placed for accurate viewing on the central control console. This wide range of comforts and conveniences provide constant pleasure and delight.

In fact, it is the blending of these many refinements with the robust sporting nature of the "F" that gives it such a unique personality in the world of high-performance automobiles.



SOUND OF AUTHORITY

Turn the key. The "F" bursts into a throaty baritone. Heads turn, you tingle. A touch of the toe proves more. This car means what it says! For the 300-F's brilliantly engineered Ram-Injection V-8 is a strong and willing servant.

Here is a design backed by experimentation on the world's most renowned racing courses. Meticulously prepared Chrysler V-8 engines have powered around the Indianapolis Speedway in spectacular fashion; carried the Cunningham-built sports cars to numerous successes at Watkins Glen, New York; helped represent the USA at the Twenty-Four Hours of Le Mans in France.

LESSONS WELL LEARNED. These lessons were not ignored. A look at the "300" legend reveals why. The first of the 300's in 1955 was the first full-fledged

production car to deliver a full 300 horsepower, its V-8 engine incorporating many modifications common to its racing cousins. In 1956, the "B" series was the champion of American stock-car racing, carried off both AAA and NASCAR titles, topped the unlimited stock class at Daytona. The 300-C carried on the tradition at Daytona, while the "D" earned its spurs as a true road artist in a number of American rallies. The "E," called the "best looking American hard-top" by the authoritative magazine Motor Trend, was considered the "300" with the greatest wallop from standstill to sixty.

When you raise the long, louvered hood of the 300-F, you sense the tradition that designed and built the engine nestling there. From this V-8 comes

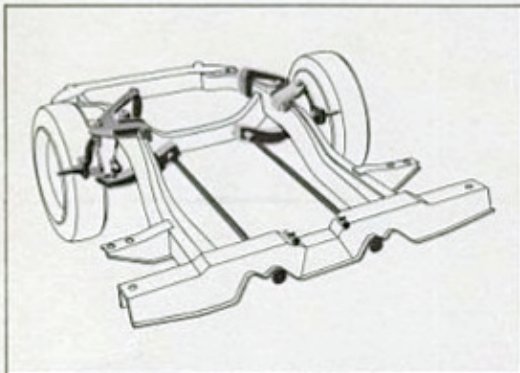

SUSPENSION. Specially engineered torsion bars at front have been designed to adapt to 300-F performance. Shock absorbers, rear leaf springs give firmer, more controllable handling.

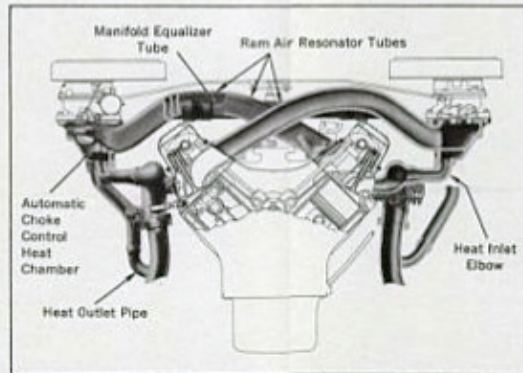

RAM INDUCTION. Special long-tube manifolds deliver instant response. Air rushing through tubes provides a super-charging effect for fuel-air mixture. High-performance plugs provide high-efficiency ignition.

instant power, surging through long aluminum tube manifolds carefully "tuned" to deliver maximum punch at speeds you use, and *need*, most!

Twin 4-barrel carburetion delivers the potency. High-performance plugs ignite it. Dual exhausts help put it efficiently on the road.

Look long. Look careful. This engine's built for moving. And you don't need an engineering degree to know it!

ROAD MANNERS. Impeccable, by every known measurement. That's the 300-F's behavior on any road. Ideal for super-highways. Pure joy on off-the-pike jaunts. Power-assisted steering provides quick, positive action with only 3 1/2 turns lock-to-lock. The most advanced torsion bar front suspension in the

American industry is specifically engineered to permit terrier-like cornering. Unbelievable for a car of this stature.

Braking is powerful. And also power-assisted. Stops are smooth and sure with a minimum of "nose-dive." Specially crafted sports-racing tires enable high averages in complete comfort and safety. Ride is firm, yet restful. There is an exciting feel of aliveness as you cruise. A brilliantly engineered single-unit body construction minimizes vibrations, shields you from exterior distraction. And it's a design that's a million miles proved.

BIG DRAWN. 413 cubic inches of slingshot performance awaits the toe of the 300-F driver. Maximum efficiency is yours at speeds you need most.

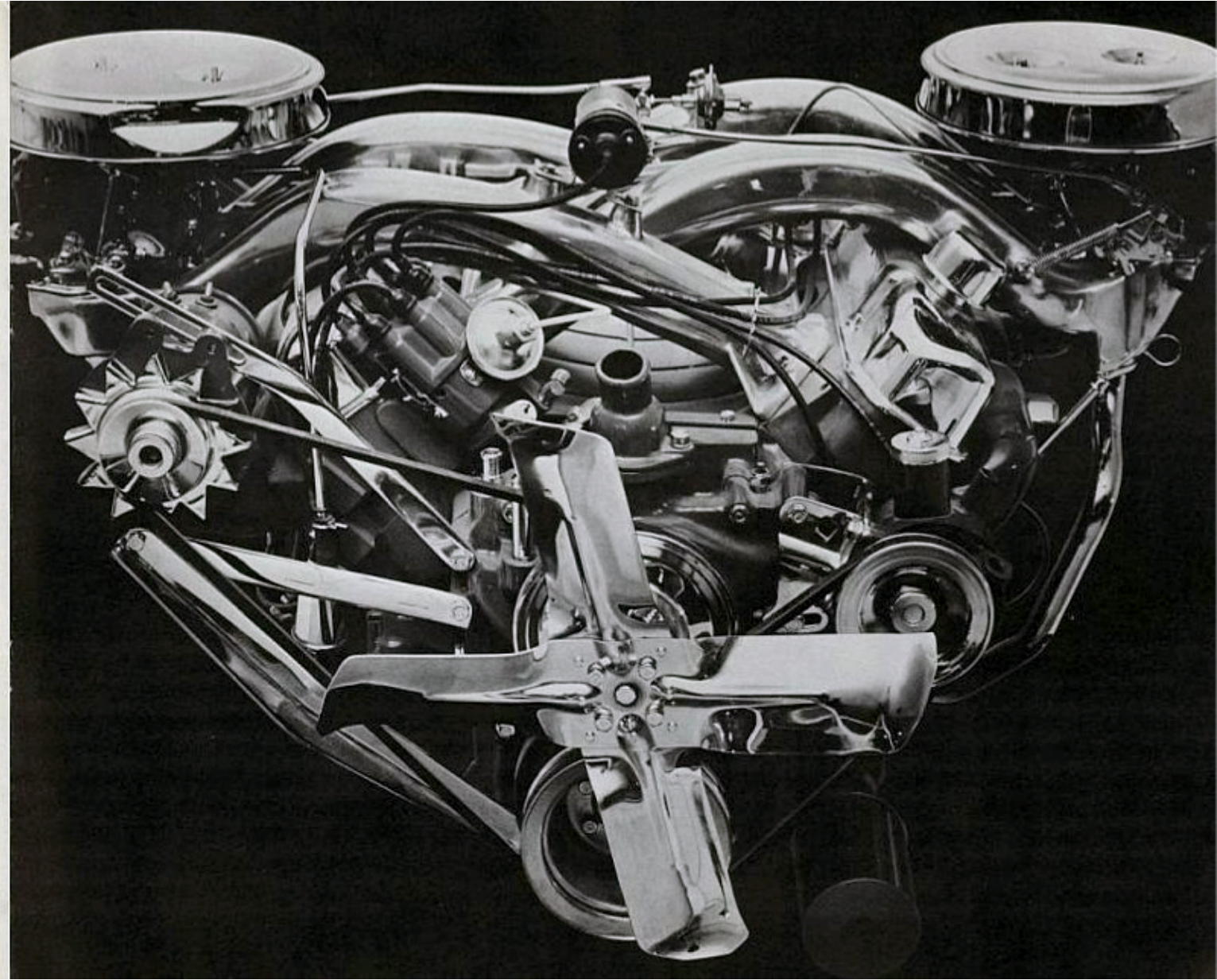

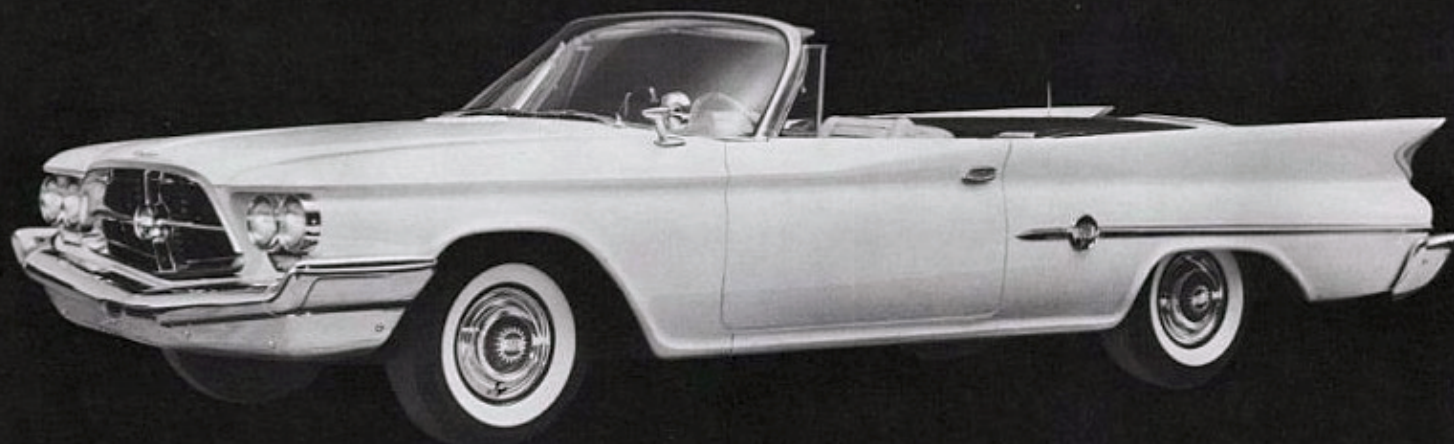

TO WHOM IT MOST CONCERNS: *There will be many who will admire the enormous potential of the 300-F. There will be relatively few to whom it will be delivered. Chrysler will continue to lavish special, unhurried attention on this rare kind of car. And expects only a rare kind of man to invest in it. If you are numbered among those several hundreds (to whom an automobile of the grand class is an exciting challenge), we suggest that you arrange a trial run. The wheel that you will grasp will belong to the most exclusive, exciting, engineered-for-action car made in America.*

SPECIFICATIONS AND EQUIPMENT

DIMENSIONS—Wheelbase, 126 in.; front tread, 61.2 in.; rear, 60.0 in.; over-all length, 219.6 in.; width, 79.4 in.; height, 55.1 in. (Hardtop) and 55.5 in. (Convertible).

ENGINE—New 300-F 90° V-8, wedge-type combustion chamber; over-head in-line valve arrangement. High output camshaft, heavy-duty valve springs and dampers. Bore and Stroke, 4.18 x 3.75. Piston displacement, 413 cu. in. Compression Ratio, 10.1 to 1. Brake horsepower, 375 at 5000 rpm. Torque, 495 lb.-ft. at 2800 rpm.

FUEL AND LUBRICATING SYSTEM—Ram-tuned manifold with two 4-barrel downdraft carburetors, mechanically controlled secondary system with auxiliary velocity valves, integral automatic choke. Dual paper element air cleaners. Mechanical fuel pump. Full-Flow oil filter.

ELECTRICAL SYSTEM—12-Volt Battery, 78-plate, 70 amp.-hr.; 35-amp. generator. Waterproof ignition.

STEERING—Constant-Control power steering, standard. Symmetri-

cal idler arm steering linkage. 3¼ turns, lock-to-lock.

TRANSMISSION—TORQUEFLITE—Fully automatic torque converter with three-speed planetary gear set. Pushbutton control in instrument panel.

CHASSIS—Special heavy-duty torsion bars, rear leaf springs and shock absorbers.

BRAKES—Chrysler Total-Contact braking system with power brakes, standard.

TIRES—"Blue Streak" high-performance, nylon super-cushion, tubeless white sidewall, 9-00 x 14. Inflation pressure—normal driving, 22 lbs.; for high speed, 30 lbs.

REAR AXLE RATIO—3.31 to 1. (2.93, 3.15, 3.23, 3.54, or 3.73 available with optional engine and transmission.)

STANDARD EQUIPMENT—Custom Steering Wheel; Safety Cushion Dash Panel; Prismatic Rearview Mirror; Nylon High-Performance White Sidewall Tires; Electric Clock; Directional Signals; Hand-

brake Warning Signal; Power Brakes and Power Steering; TorqueFlite Transmission; Chrome Stainless Steel Wheel Covers; Windshield Washer; Undercoating and Hood Insulation Pad; Leather Upholstery; Dual Headlamps; Silent-Flite Fan Drive (limits fan speed to 2500 rpm); Swivel Seats; Low Back Pressure Exhaust System; Power Windows; Tachometer; Flight-Sweep Deck Lid; Center Armrests—front and rear.

OPTIONAL EQUIPMENT (at extra cost)—Air Conditioning; Electro Touch Tuner or Music Master Radio; Rear Shelf Radio Speaker (Hardtop); Power Antenna; Manual or Remote Control Outside Rearview Mirror; Mirromatic; Automatic Beam Changer; Rear Window Defroster (Hardtop); Pushbutton Custom Conditionaire Heater; 6-Way Power Seat; Tinted Glass; Shaded Back Light (Hardtop); Sure-Grip Differential; 400 hp Engine and Manual 4-speed Synchronesh Transmission.

All Specifications, Equipment and Prices subject to change without notice.

exclusive, exciting, engineered for action



CHRYSLER AND IMPERIAL DIVISION • DETROIT, MICHIGAN